

Free-Space Optical Isolators

Optical Isolator Tutorial (Page 1 of 2)

Function

An optical isolator is a passive magneto-optic device that only allows light to travel in one direction. Isolators are used to protect a source from back reflections or signals that may occur after the isolator. Back reflections can damage a laser source or cause it to mode hop, amplitude modulate, or frequency shift. In high power applications, back reflections can cause instabilities and power spikes.

An isolator's function is based on the **Faraday Effect**. In 1842, Michael Faraday discovered that the plane of polarized light rotates while transmitting through glass (or other materials) that is exposed to a magnetic field. The direction of rotation is dependent on the direction of the magnetic field and not on the direction of light propagation; thus, the rotation is non-reciprocal. The amount of rotation θ equals $V L H$, where V , L , and H are as defined below.

Product Presentation Starts on Page 676

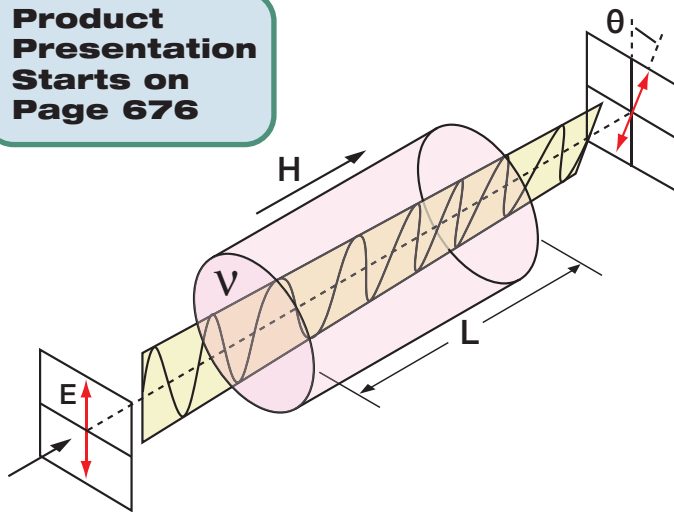

OPTICAL ISOLATORS

Faraday Rotation

$$\theta = V \times L \times H$$

V: the Verdet Constant, a property of the optical material, in minutes/Oersted-cm.

L: the path length through the optical material in cm.

H: the magnetic field strength in Oersted.

An optical isolator consists of an input polarizer, a Faraday rotator with magnet, and an output polarizer. The input polarizer works as a filter to allow only linearly polarized light into the Faraday rotator. The Faraday element rotates the input light's polarization by 45° , after which it exits through another linear polarizer. The output light is now rotated by 45° with respect to the input signal. In the reverse direction, the Faraday rotator continues to rotate the light's polarization in the same direction that it did in the forward direction so that the polarization of the light is now rotated 90° with respect to the input signal. This light's polarization is now perpendicular to the transmission axis of the input polarizer, and as a result, the energy is either reflected or absorbed depending on the type of polarizer.

Operation of an Isolator

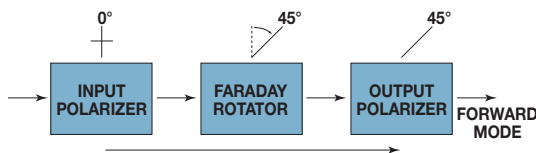

The Forward Mode

Laser light, whether or not polarized, enters the input polarizer and becomes linearly polarized, say in the vertical plane (0°). It then enters the Faraday rotator rod, which rotates the plane of polarization (POP) by 45° , in the clockwise sense. Finally, the light exits through the output polarizer whose axis is at 45° . Therefore, the light leaves the isolator with a POP of 45° .

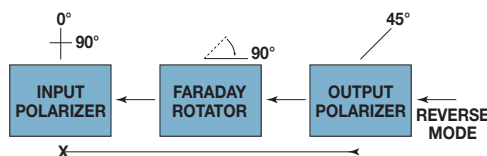

The Reverse Mode

Light traveling backwards through the isolator will first enter the output polarizer, which polarizes the light at 45° with respect to the input polarizer. It then passes through the Faraday rotator rod, and the POP is rotated another 45° in the positive direction. This results in a net rotation of 90° with respect to the input polarizer, and thus, the POP is now perpendicular to the transmission axis of the input polarizer. Hence, the light will either be reflected or absorbed.

Optical Isolator Tutorial (Page 2 of 2)

History

OFR, a division of Thorlabs, has been manufacturing optical isolators from the beginning. In fact, OFR introduced the optical isolator to the world's photonics market. Having designed more than 100 models in response to customers' requirements since the early 1980s, OFR now produces more models of optical isolators than any other manufacturer.

Faraday rotator crystal rods are optically ground and polished in the OFR optical shop using OFR-designed tooling. The end faces of the rotator rods are ground and polished to <5 arc seconds parallel. Thus, end face specifications are maintained under OFR control. This, along with 100% internal inspection (for inclusions and strain-birefringence) of all Faraday rotator crystal rods, ensures that all isolators meet OFR's specifications.

OFR manufactures optical isolators for virtually all lasers from 350 to 2100nm and beyond. Most models are available with low-power or high-power polarizers.

General Information

An isolator is used to reduce or eliminate the effects of optical feedback and reflections of the laser's own energy back onto itself. Feedback can cause a source to become unstable with amplitude fluctuation, frequency shift, mode hopping, noise, and even damage. A Faraday isolator relies on a magneto-optic effect to provide a non-reciprocal rotation that only allows light to travel in one direction through the isolator.

Damage Threshold

OFR Isolators typically have higher transmittance and isolation compared to all other isolators on the market. Furthermore, because of certain proprietary features (covered by 25 years of experience and 5 US patents), OFR Isolators are smaller and have higher performance than any units of equivalent aperture available anywhere. For visible to YAG laser Isolators, OFR's Faraday Rotator crystal of choice is TGG (terbium-gallium-garnet), which is unsurpassed in terms of optical quality, Verdet constant, and resistance to high laser power. OFR TGG Isolator rods have been damage tested to $22.5\text{J}/\text{cm}^2$ at 1064nm in 15ns pulses ($1.5\text{GW}/\text{cm}^2$), and to $20\text{kW}/\text{cm}^2$ CW. However, OFR does not bear responsibility for laser power damage that is attributed to "hot spots" in the beam.

Magnet

The magnet is a major factor in determining the size and performance of an Isolator. The ultimate size of the magnet is not simply determined by magnetic field strength but is also influenced by the mechanical design. Many OFR magnets are not simple one piece magnets but are complex assemblies. OFR's modeling systems allow optimization of the many parameters that affect size, optical path length, total rotation, and field uniformity. OFR's US Patent 4,856,878 describes one such design that is used in several of the larger aperture Isolators for YAG lasers. OFR emphasizes that a powerful magnetic field exists around these Isolators, and thus, steel or magnetic objects should not be brought closer than 5cm.

Temperature

The magnets and the Faraday rotator materials both exhibit a temperature dependence. Both the magnetic field strength and the Verdet Constant decrease with increased temperature. For operation greater than $\pm 10^\circ\text{C}$ beyond room temperature, please contact Technical Support.

Pulse Dispersion

Pulse broadening occurs anytime a pulse propagates through a material with an index of refraction greater than 1. This dispersion increases inversely with the pulse width and therefore can become significant in ultrafast lasers.

τ – Pulse Width Before Isolator

$\tau_{(2)}$ – Pulse Width After Isolator

Example: $\tau = 120\text{fs}$ results in $\tau_{(2)} = 186\text{fs}$

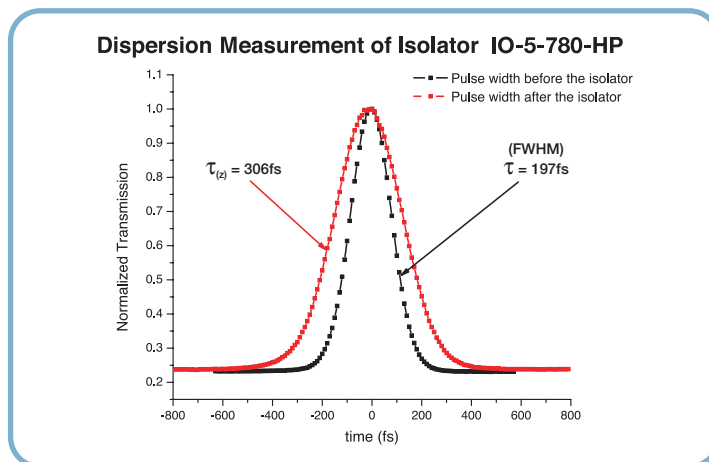

Free-Space Optical Isolators

Volume Production of Optical Isolators

OFR, a company with a 35 year history, became a division of Thorlabs in January 2007. Shortly afterwards, the OFR group began a rapid expansion of its optical isolator production facilities with support from a team of Thorlabs lean manufacturing experts. Driven in large part by the growing demand created by the rapid expansion of the fiber laser market, OFR/Thorlabs is now producing significant volumes of optical isolators. If you need an isolator not shown on the following pages, please contact your local OFR or Thorlabs office.

Fixed Narrowband Isolator

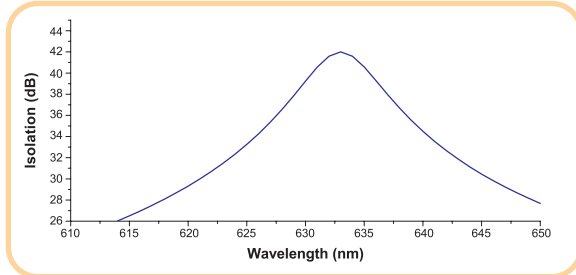

Fixed Rotator Element, Fixed Polarizers:

The isolator is set for 45° of rotation at the design wavelength. The polarizers are non-adjustable and are set to provide maximum isolation at the design wavelength. As the wavelength changes the isolation will drop; the graph shows a representative profile. For OEM and custom applications that require isolation at a non-standard wavelength, contact OFR.

- Polarization Dependent and Independent
- Smallest and Least Expensive Isolator Type
- No Tuning

Adjustable Narrowband Isolator

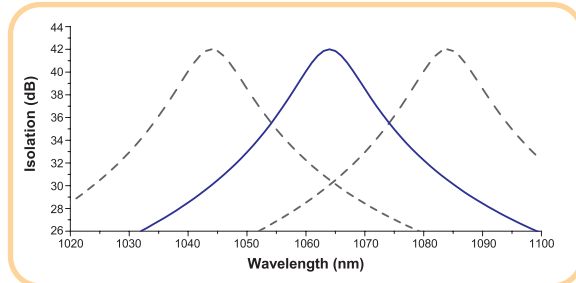

Fixed Rotator Element, Adjustable Polarizers:

The isolator is set for 45° of rotation at the design wavelength. If the usage wavelength changes, the Faraday rotation will change thereby decreasing the isolation. To regain maximum isolation, the polarizers can be rotated to “center the curve,” and the isolation will follow a Gaussian profile.

- Polarization Dependent
- General Purpose Isolator
- Tuning Range: ~60nm

Adjustable Broadband Isolator

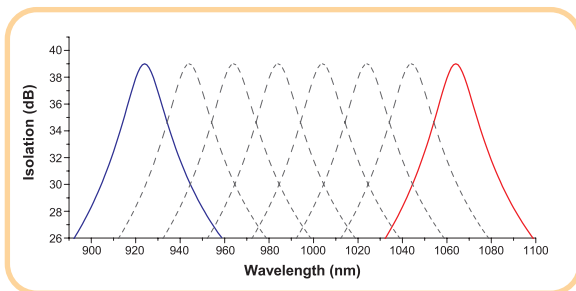

Adjustable Rotator Element, Fixed Polarizers:

The isolator is set for 45° of rotation at the design wavelength. There is a tuning ring on the isolator that adjusts the amount of Faraday rotator material that is inserted into the internal magnet. As your usage wavelength changes, the Faraday rotation will change thereby decreasing isolation. To regain maximum isolation, the tuning ring is adjusted to produce the 45° of rotation necessary for maximum isolation.

- Polarization Dependent
- Simple Tuning Procedure
- Tuning Range: ~200nm

Fixed Broadband Isolator

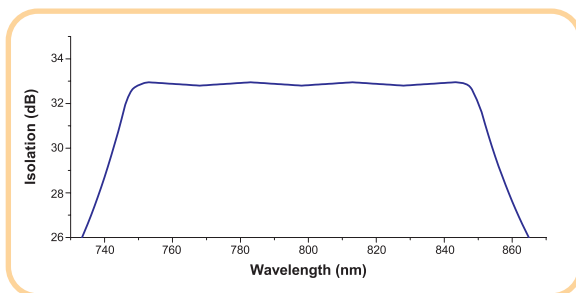

Fixed Rotator Element, Fixed Polarizers:

A 45° Faraday rotator is coupled with a 45° crystal quartz rotator to produce a combined 90° rotation on the output. The wavelength dependence of the two rotator materials work together to produce a flat-top isolation profile. The isolator does not require any tuning or adjustment for operation within the designated design bandwidth.

- Polarization Dependent
- Largest Isolation Bandwidth
- No Tuning Required

ISOLATOR TYPE	405nm	633nm	780nm	830-850nm	1064nm	1310nm	1550nm	2050nm
Fixed Narrowband		X	X	X	X ⁽¹⁾	X	X	
Adjustable Narrowband	X	X	X	X	X	X	X	X
Adjustable Broadband			X	X	X			
Fixed Broadband				X				

(1) Polarization independent and dependent models

Isolator Selection Guide

ITEM#	WAVELENGTH	POWER RATING	APERTURE	TRANSMISSION	ISOLATION	PAGE
IO-5-405-LP	405nm	100W/cm ²	5mm	≥84%	32-42dB	676
IO-2D-633-VLP	633nm	25W/cm ²	2mm	71 – 75%	35-40dB	676
IO-3D-633-VLP	633nm	25W/cm ²	3mm	71 – 75%	34-40dB	676
IO-3D-633-PBS	633nm	13W/cm ²	3mm	88%	30-36dB	676
IO-3-633-LP	633nm	100W/cm ²	3mm	>93%	35-40dB	676
IO-5-633-PBS	633nm	13W/cm ²	5mm	86 – 90%	33-38dB	676
IO-5-NIR-LP	700 - 925nm	100W/cm ²	4.7mm	≥91%	36-40dB	677
IO-D-780-VLP	780nm	25W/cm ²	1.75mm	48 – 55%	≥40dB	677
IO-3D-780-VLP	780nm	25W/cm ²	3mm	>86%	34-40dB	677
IO-3-780-HP	780nm	500W/cm ²	2.7mm	>92%	34-40dB	677
IO-5-780-HP	780nm	500W/cm ²	5mm	>92%	38-44dB	677
IO-5BB-800-HP	748-851nm	500W/cm ²	4.7mm	≥88%	≥33dB	677
IO-3D-830-VLP	830nm	25W/cm ²	3mm	≥86%	34-40dB	677
IO-3D-850-VLP	850nm	25W/cm ²	3mm	≥86%	34-40dB	677
IO-3-850-HP	850nm	500W/cm ²	2.7mm	>92%	34-40dB	677
IO-5-850-HP	850nm	500W/cm ²	5mm	>92%	38-44dB	677
IO-5-TIS2-HP	780-1000nm	500W/cm ²	4.7mm	≥91%	≥39dB	679
IO-D-1064-VLP	1064nm	25W/cm ²	1.75mm	≥80%	>40dB	678
IO-2.5-1064-VLP	1064nm	25W/cm ²	2.5mm	≥78%	>40dB	678
IO-2.5E.1064-VLP	1064nm	25W/cm ²	2.5mm	≥86%	>28dB	678
IO-3D-1064-VLP	1064nm	25W/cm ²	3mm	90-92%	38-44dB	678
IO-3-1064-HP	1064nm	500W/cm ²	2.8mm	≥93%	38-44dB	679
IO-3-1064-VHP	1064nm	20kw/cm ²	2.8mm	≥91%	35-44dB	678
IO-5-1064-HP	1064nm	750W/cm ²	4.8mm	≥93%	38-44dB	679
IO-5-1064-VHP	1064nm	20kw/cm ²	4.8mm	≥91%	35-44dB	679
IO-8-1064-HP	1064nm	750W/cm ²	7.8mm	>92%	33-40dB	679
IO-10-1064-VHP	1064nm	20kw/cm ²	9.8mm	90 – 92%	35-44dB	679
IO-1.2PI-1064-PBB	1064nm	2kw/cm ²	1.2mm	≥93%	≥30dB	679
IO-D-1310-VLP	1310nm	1W	1.75mm	>95%	≥40dB	680
IO-2.5-1310-VLP	1310nm	25W/cm ²	2.5mm	>95%	>38dB	680
IO-4-1310-VLP	1310nm	25W/cm ²	4mm	>95%	>38dB	680
IO-D-1550-VLP	1550nm	1W	1.75mm	>95%	≥40dB	681
IO-2.5-1550-VLP	1550nm	25W/cm ²	2.5mm	>95%	>38dB	681
IO-2.5-1550-HP	1550nm	500W/cm ² *	2.5mm	>92%	>38dB	681
IO-4-1550-VLP	1550nm	25W/cm ²	4mm	>95%	>38dB	681
IO-5-1550-HP	1550nm	500W/cm ² *	5mm	>92%	>38dB	681
IO-4-2050-HP	2050nm	500W/cm ² *	4mm	>90%	>33dB	682

* The Power limit is 20W (CW) but cannot exceed 500W/cm².

Polarizer Types and Power Limits

Several types of polarizers are available to meet specific application needs. All Glan, Cube, and Brewster polarizers are manufactured and assembled in the OFR optical shop using OFR-designed tooling. VLP polarizers are an absorptive film type used in compact low-power applications. PBS are low power cubes that are useful for monitoring and injection-locking applications. LP polarizers are a Glan-type polarizer with very high transmission and isolation values. HP polarizers are also a Glan-type polarizer, can handle high power, and have an escape window that can be used for injection-locking. VHP polarizers are Brewster window polarizers that offer very high damage thresholds.

VLP	PBS	LP	HP	VHP
Very Low Power absorptive film polarizer. Smallest package and usually least expensive.	Polarizing Beam Splitter cube. Low power applications. Good for injection locking applications.	Low Power Glan-type crystal polarizer. Larger package size but very high transmission.	High Power Glan-type crystal polarizer. Larger package size but very high transmission. Can also be used in injection locking applications.	Very High Power Brewster window polarizer. Highest power possible, largest package, narrow-band, lower cost than HP.
25W/cm ² (CW)	13W/cm ² (CW)	100W/cm ² (CW)	500W/cm ² (CW)	20kW/cm ² (CW)
300kW/cm ² (pulsed)**	–	25MW/cm ² (pulsed)**	200MW/cm ² (pulsed)**	1GW/cm ² (pulsed)**

** Based on 20ns pulse, 20Hz at 1064nm.